

shape CUT
YOUR
STYLE

Washbasin 70

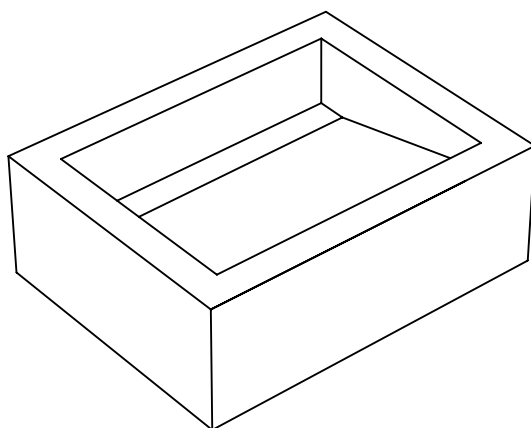

FONDOVALLE

Assembly instructions

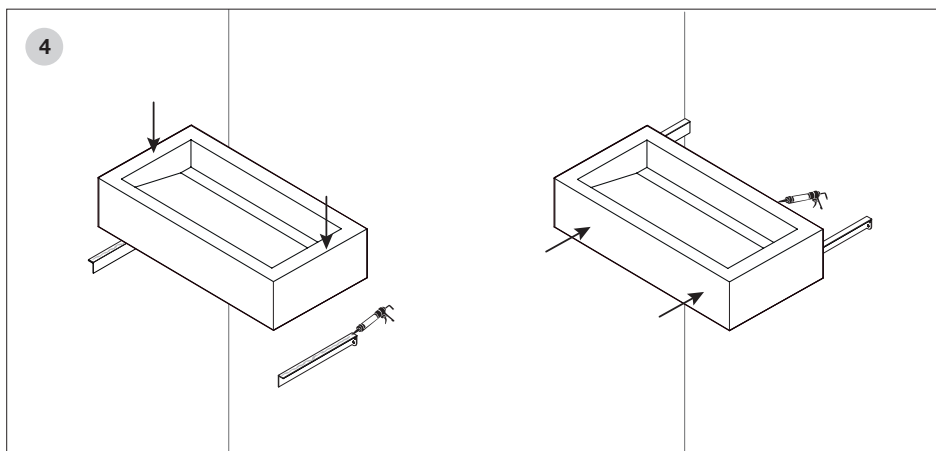
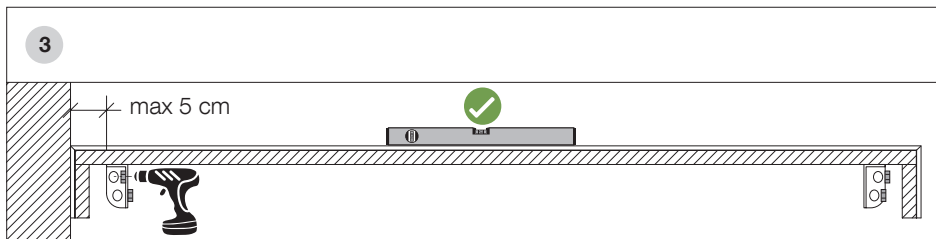
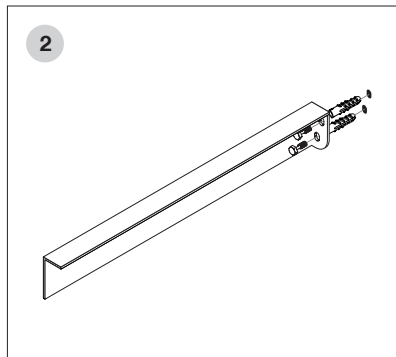
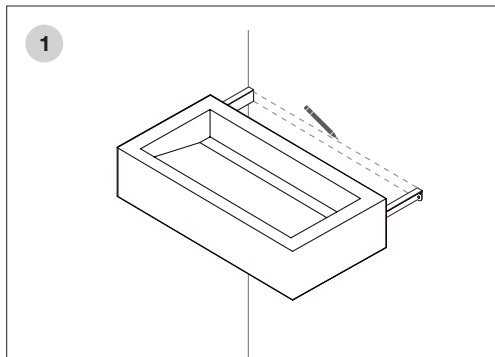

Tools needed



Pencil



Tape
measure



Spirit level



Drill



Power
screwdriver



Hammer



Screwdriver



Silicone

RECOMMENDATIONS



Use protective gloves

Preliminary stage

Check the kind and condition of the wall on which the washbasin will be mounted, making sure there is no wiring and/or plumbing inside it.

Mark the washbasin installation height. Calculate the height of the washbasin (bearing in mind the thickness of the supporting wall) and position the brackets underneath this. Where there is a drain hole already featured, calculate the height of the drain according to the washbasin model.

1 Preparation for fastening

Place the bracket against the wall and mark the positions for the screw anchor holes.

2 Anchor insertion

Make a hole in the wall for each anchor, with the same sized diameter as the anchor. Screw the screw partway into the anchor. Insert the anchors (with the screws inside) into the wall and then hammer gently until they are flush with the wall. Tighten the screw fully and then unscrew it. NB. The anchor must be chosen by the worker assigned following the instructions given by the anchor supplier.

3 Bracket mounting

Place the brackets in position and then tighten the screw again fully and permanently.

4 Fitting the washbasin

Position the top on top of the brackets and, using a spirit level, check that there are no sloping areas. TIP: if there is a slope, a shim must be applied to the bottom of the bracket plate in contact with the wall.

Apply structural silicone or glue for porous/non-porous surfaces along the entire length of the brackets. Fit the top and apply pressure. Wait 24 hours before adding any more weight. Fill the joints between the top and the wall (min. 1 mm) with silicone. IMPORTANT: if the top is fitted between one or more walls, the brackets must be positioned at least 5 cm away from the wall(s). Where this is not possible, we recommend you install a corner support.

Wall-mounted units.
Can be supplied with tap hole on request.

Type

Sloping with pop-up plug and trim base

MIXER TAP

Wall-mounted

Incluso

GFB SIFON 00056742 stainless steel drain. Support brackets: 30/10 galvanized iron with slots

FAO- approved crate packaging

height: 452 mm

size: 760x1320 mm

weight: 85 kg

Washbasin dimensions

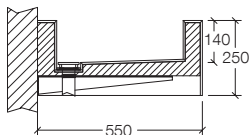
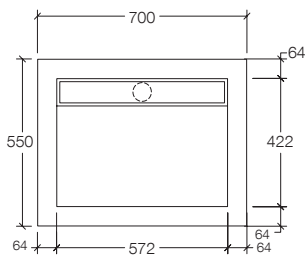

Bracket dimensions

RH

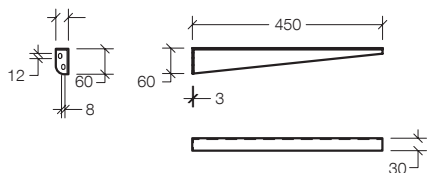

LH

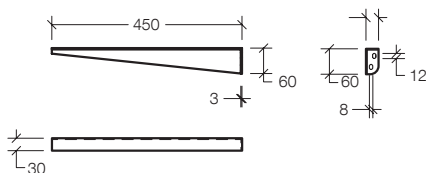

FONDOVALLE

www.fondovalle.it | info@fondovalle.it